

QLPCT

PRECISION THRUST CLAMPS



(Clamping)

(Unclamping)

Body	Clamping Bar
AC7A aluminum Anodized	S45C steel Solid film lubricated
Linkage End	Knob
S45C steel Black oxide finished	Phenolic plastic Black

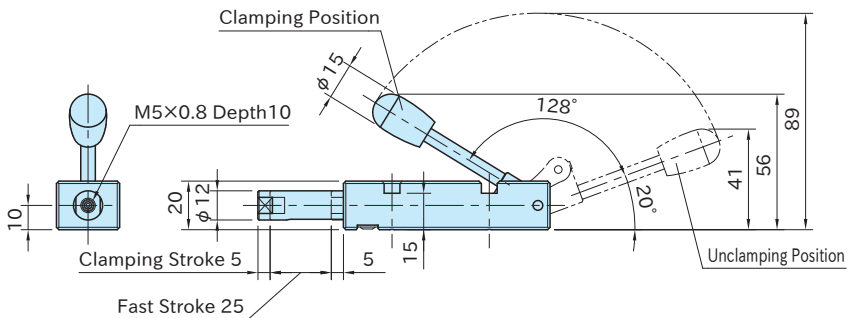
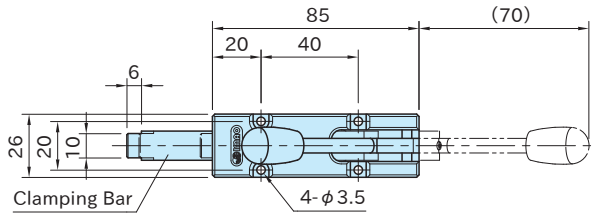

Part Number	Clamping Force(N) Initial - Final *)	Weight (g)
QLPCT20-07	55~ 85	170
QLPCT20-13	90~175	

*) The minimum clamping force at clamping end position, and the maximum clamping force at clamp starting position.

Feature

- Precision Thrust Clamps can clamp at the same position by precise projection of clamping bars.
- Spring-loaded clamp provides constant clamping force.
- The handle clicks to indicate completed clamping.

Note

How to Install Attachments

When installing an attachment on the clamping bar, lock the clamping bar using a wrench to prevent it from receiving any torque.

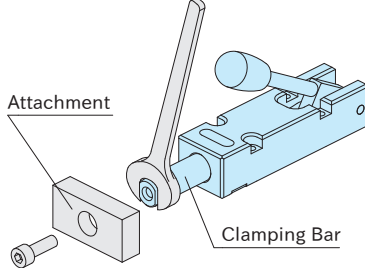

How to Replace Handle

The handle is replaceable.

When installing/removing a handle, do not apply torque to the Linkage End.

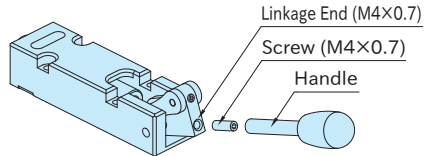

Technical Information

Allowable Load and Accuracy of Clamping Bar

- Allowable Weight of Attachments on Clamping Bar ... 500g
- Deflection ... ± 0.05
- Allowable Rotation Torque ... $0.5\text{N}\cdot\text{m}$
- Rotation Accuracy
 - ... $\pm 0.1^\circ$ (Under no load)
 - ... $\pm 1^\circ$ (Under load at allowable rotation torque)

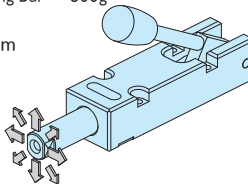

<Allowable Weight / Deflection>

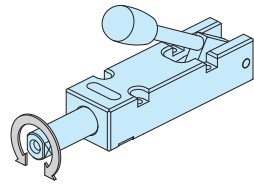

<Allowable Rotation Torque / Rotation Accuracy>

How To Use

For clamping a recessed part / clamping with constant clamping force

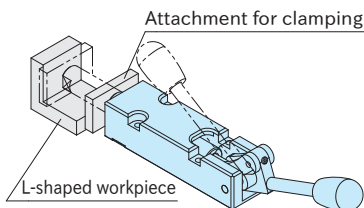

For press-fit fixtures and conduction test fixtures that require precise projection of clamping bars.

